

VELTRON DPT

ULTRA-LOW DIFFERENTIAL PRESSURE AND FLOW TRANSMITTER

MOUNTING CONFIGURATIONS

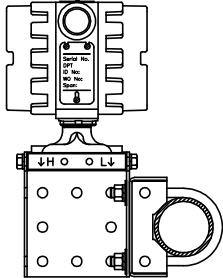

ANGLE MOUNT TO HORIZONTAL PIPE

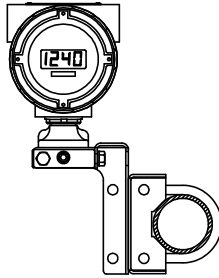

VERTICAL MOUNT TO HORIZONTAL PIPE

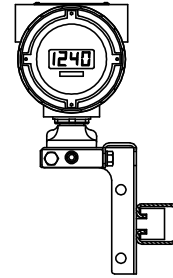

VERTICAL MOUNT TO HORIZONTAL CHANNEL

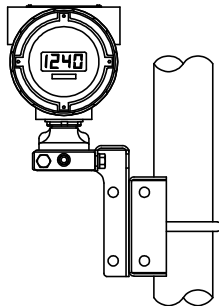

VERTICAL MOUNT TO VERTICAL PIPE

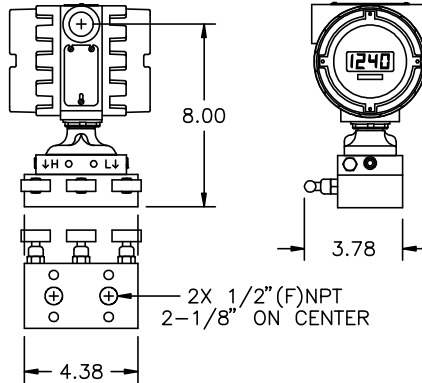

OPTIONAL 3 VALVE MANIFOLD

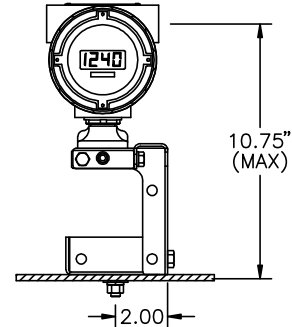

ANGLE MOUNT TO FLAT SURFACE

NOTE: MOUNTING BRACKET KIT INCLUDES 3/8"-16 U-BOLTS, NUTS & WASHERS FOR 2" SCH 40 PIPE PLUS 4 BOLTS & WASHERS TO ATTACH THE TRANSMITTER TO THE MOUNTING BRACKET.

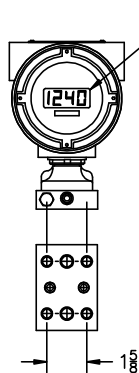

OPTIONAL LCD DISPLAY

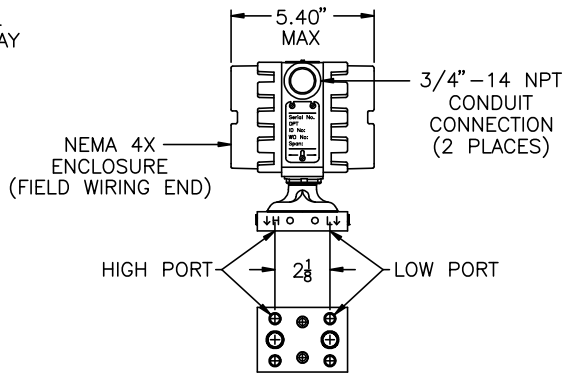

NEMA 4X ENCLOSURE (FIELD WIRING END)

3/4" - 14 NPT CONDUIT CONNECTION (2 PLACES)

HIGH PORT

LOW PORT

1/4" - 18 NPT (FOR PRESSURE CONNECTIONS)

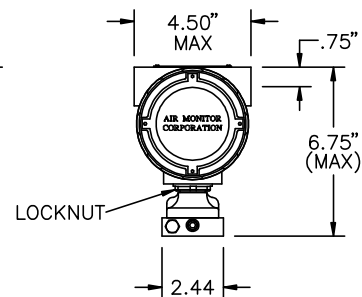

LOCKNUT

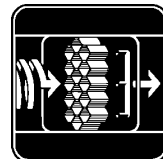

AIR MONITOR CORPORATION