

# Installation, Operation, and Maintenance Manual

## **VELTRON DPT 2500-*plus***

**Microprocessor Based Ultra-Low Range  
Pressure & Flow "Smart" Transmitter**

**Version 1.0X**

**Installation, Operation & Maintenance**

**Air Monitor Corporation provides complete  
technical support between the hours of  
7 a.m. and 5 p.m. PST, M-F**

**Contact our Service Department  
Toll Free: 1-800-AIRFLOW**

**or fax us at 1-707-526-2825**





<b>TABLE OF CONTENTS</b>
--------------------------

<b>INSTRUMENT WARRANTY</b> .....	i
 <b>SECTION 1 – GENERAL INFORMATION</b>	
1.1 DESCRIPTION .....	1
1.2 THEORY OF OPERATION .....	1
 <b>SECTION 2 – PERFORMANCE SPECIFICATIONS</b>	
2.1 TRANSMITTER .....	2
2.2 INDICATION .....	2
2.3 OUTPUTS .....	2
2.4 POWER .....	2
 <b>SECTION 3 – FEATURES</b>	
3.1 USER SETUP MENU .....	3
3.2 TRANSMITTER HOLD .....	3
3.3 AUTOMATIC ZEROING .....	3
3.4 DATA DISPLAY .....	3
3.5 HIGH TURNDOWN RATIO OPERATION .....	3
3.6 ENCLOSURE .....	3
3.7 MULTIPLE OPERATING POWER SELECTIONS .....	3
 <b>SECTION 4 – INSTALLATION</b>	
4.1 RECEIVING AND INSPECTION .....	4
4.2 LOCATION .....	4
4.3 MOUNTING .....	5
4.4 PROCESS CONNECTIONS .....	6
4.5 POWER/SIGNAL CONNECTIONS .....	7
4.6 OUTPUT SELECTION .....	7
4.7 DISPLAY CONTRAST ADJUSTMENT .....	7
 <b>SECTION 5 – OPERATION</b>	
5.1 INTRODUCTION .....	8
5.2 START-UP .....	8
5.3 NORMAL OPERATION .....	9
5.4 CONFIGURATION .....	9
5.5 PUSHBUTTON DEFINITION .....	10
5.6 CONFIGURATION PROGRAMMING .....	11-12
5.7 TRANSMITTER SCALING & CONFIGURATION .....	13-17
5.8 LOW PASS FILTER .....	18
5.9 AUTO-zero CONFIGURATION .....	19
5.10 TRANSDUCER SPAN SELECTION .....	20
5.11 TRANSMITTER INPUT CALIBRATION .....	21
5.12 TRANSMITTER OUTPUT CALIBRATION .....	21

<b>TABLE OF CONTENTS</b>
--------------------------

**SECTION 6 – CALIBRATION**

6.1	REQUIRED EQUIPMENT .....	22
6.2	PREPARATION .....	22
6.3	TRANSMITTER INPUT CALIBRATION .....	23-25
6.4	TRANSMITTER OUTPUT CALIBRATION .....	26-27

<b>SECTION 7 – MAINTENANCE .....</b>	<b>28</b>
--------------------------------------	-----------

<b>SECTION 8 – TROUBLESHOOTING .....</b>	<b>29</b>
--	-----------

<b>SECTION 9 – PARTS LIST .....</b>	<b>30</b>
-------------------------------------	-----------

<b>SECTION 10 – CUSTOMER SERVICE .....</b>	<b>31</b>
--	-----------

**INSTRUMENT WARRANTY**

Air Monitor Corporation (hereinafter referred to as "Seller") warrants that at the time of shipment, products sold pursuant to this contract will be free from defects in materials and workmanship, and will conform to the specifications furnished or approved in writing by Seller. No warranty is given that delivered products will conform to catalog sheets, data sheets, and the like, which are subject to change without notice.

Seller will repair or replace, at its option, any products listed under this warranty which is returned freight prepaid to Seller within the earlier of three (3) years after start-up or thirty-nine (39) months after shipment that, upon test and examination, proves defective within the terms of this warranty. The warranty period for any item repaired or replaced shall be for the time remaining on the warranty period of the original components. Purchaser shall notify Seller in writing of such defect within sixty (60) days of discovery of the defect.

This warranty does not extend to any product sold by Seller which has been the subject of misuse, neglect, accident, damage or malfunction caused by interconnection with equipment manufactured by others, improper installation or storage, or used in violation of instructions furnished by Seller, nor does it extend to any

product which has been repaired or altered by persons not expressly approved by Seller. Nor does Seller warrant equipment against normal deterioration due to environment; nor items such as lamps, glass, and similar items subject to wear or burnout through usage. Adjustments for items or equipment not manufactured by Seller shall be made to the extent of any warranty of the manufacturer or supplier thereof.

Seller shall not be liable for any special or consequential damages or for loss of damage, directly or indirectly arising from the use of the products. Seller's warranty shall be limited to replacement of defective equipment and shall not include field removal and installation expenses.

The warranty set forth above is in lieu of all other warranties either express or implied and constitutes the full extent of Air Monitor Corporation's liability to the customer, or any other party for breach of warranty.

THERE ARE NO EXPRESS WARRANTIES EXCEPT AS SET FORTH HEREIN AND THERE ARE NO IMPLIED WARRANTIES OF MERCHANTABILITY OF FITNESS FOR ANY PARTICULAR PURPOSE, WHICH ARE PARTICULARLY DISCLAIMED.

**NOTICE OF PROPRIETARY RIGHTS**

This document contains confidential technical data, including trade secrets and proprietary information which are the sole property of Air Monitor Corporation. The use of said data is solely limited to use as specified herein. Any other use is strictly prohibited without the prior written consent of Air Monitor Corporation.

# 1 – GENERAL INFORMATION

## 1.1 – DESCRIPTION

The VELTRON DPT 2500-*plus* is an ultra-low differential pressure "smart" transmitter designed to convert the low magnitude pressure signals generated by airflow stations and probes, or static pressure sensors into an output signal (4-20mA, 0-5VDC or 0-10VDC) linear to pressure or flow.

Each VELTRON DPT 2500- *plus* is equipped with numerous standard features: A multi-line LCD used during configuration/calibration and for display of process; AUTO-zero for elimination of transmitter zero error; user selectable primary signal noise filter, input power isolation; capability of 10:1 flow or 100:1 pressure turndown; and an optional NEMA 12 enclosure (NEMA 1 is standard).

## 1.2 – THEORY OF OPERATION

High and low pressure signals generated by airflow stations and probes, or static pressure sensors act upon opposite sides of a flexible diaphragm within the transducer. The differential between the two pressure signals displaces the diaphragm; the magnitude of the displacement being measured creates an electrical DC output from the transducer. After undergoing A/D conversion, the resulting digital signal representing differential pressure or velocity pressure can be "manipulated" within the microprocessor: square rooted for velocity or flow application; scaled for unit s of measure and area for process output; and scaled for local data display. The built-in microprocessor runs the program that provides the following basic functions: Timing, logic, and mathematical operations, analog input signal multiplexing, analog input/output calibration, automatic zeroing valve operation, User Setup menu system, and display (LCD) indication.

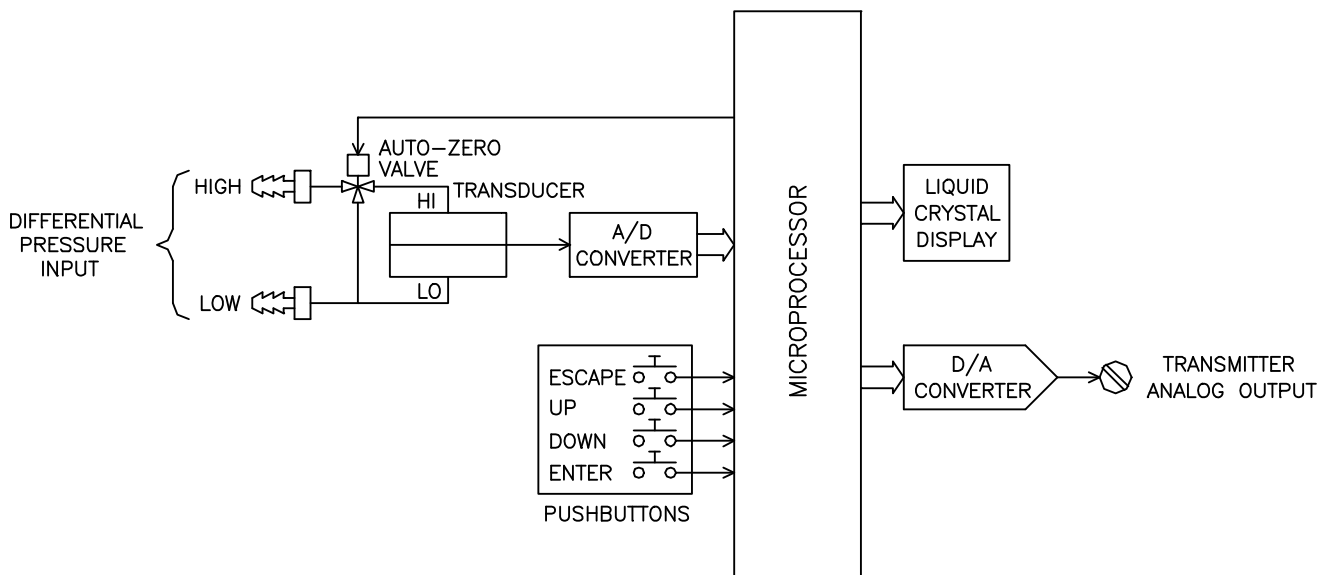

## 2 – PERFORMANCE SPECIFICATIONS

### 2.1 – TRANSMITTER

**Accuracy.** 0.25% of Natural Span, including hysteresis, deadband, non-linearity, and non-repeatability.

**Type.** Differential pressure, flow, and mass flow.

<b>Ranges.</b>	<u>Natural Spans</u>	<u>Bi-Polar Natural Spans</u>
	0 to 25.00 IN w.c.	
	0 to 10.00 IN w.c.	–10.00 to 10.00 IN w.c.
	0 to 5.00 IN w.c.	– 5.00 to 5.00 IN w.c.
	0 to 2.00 IN w.c.	– 2.00 to 2.00 IN w.c.
	0 to 1.00 IN w.c.	– 1.00 to 3.00 IN w.c.
	0 to 0.50 IN w.c.	– 0.50 to 0.50 IN w.c.
	0 to 0.25 IN w.c.	– 0.25 to 0.25 IN w.c.
	0 to 0.10 IN w.c.	– 0.10 to 0.10 IN w.c.
	0 to 0.05 IN w.c.	– 0.05 to 0.05 IN w.c.

**Span Rangeability.** The calibrated span can be down ranged to 40% of the Natural Span.

**Stability.** ±0.5% of Natural Span for six months.

**Temperature Effect.**

Zero. None; corrected by AUTO-zero.

Span. 0.015% of Natural Span/°F.

**Mounting Position Effect.** None; corrected through transmitter automatic zeroing.

**Span and Zero Adjustment.** Digital, via internally located pushbuttons.

**Low Pass Filtration.** Response time to reach 98% of a step change is adjustable from 0.5 to 256.0 seconds.

**Overpressure and Static Pressure Limit.** 25 psig.

**Automatic Zeroing.**

Accuracy. Within 0.1% of calibrated span.

Frequency. Every 1 to 24 hours on 1 hour intervals.

**Temperature Limits.** –20 to 180°F Storage; +40 to 140°F Operating.

**Humidity Limits.** 0-95% RH, non-condensing.

### 2.2 – INDICATION

**Display.** A backlit, graphical LCD providing single line of data display. Also used for programming.

### 2.3 – OUTPUTS

**Analog Output.** Single output linear to pressure, flow, or massflow configurable via jumper to 0-5V, 0-10V, or 4-20mA.

### 2.4 – POWER

**Power Supply.** Standard 24VAC (16-30VAC) or 24VDC (16-40VDC).

**Power Consumption.** Standard: 8VA at 24VAC; 6VA at 24VDC.

**Circuit Protection.** Power input is isolated, fused, and reverse polarity protected.

## 3 – FEATURES

### 3.1 – USER SETUP MENU

The microprocessor program contains a User Setup menu system for setting user selectable parameters. Four pushbuttons, (X) (↑) (↓) (↵) allow the user access to the menu for setting configuration modes and values. Refer to the Configuration Programming (Section 5.6) instructions for operation details. Also contained in the User Setup menu is all input and output calibration. The calibration method is completely digital and contains no analog potentiometer adjustments which are susceptible to drift. Non-volatile memory is used for storing all setup parameters and calibration values, and will remain unchanged after set, even when power to the unit is off.

### 3.2 – TRANSMITTER HOLD

Certain operations performed by the microprocessor place the unit into a *Hold* mode. This occurs when the User Setup menu system is activated or when an AUTO-zero is performed. When in *Hold*, all *Normal* mode processing is halted and the output is held at its last value prior to *Hold*. *Normal* operation is indicated by the "CPU Activated" ● (dot) in the lower left of the display blinking at a rate of four times per second. A *Hold* mode is indicated by the "CPU Activated" ● (dot) blinking at a rate of once per second.

### 3.3 – AUTOMATIC ZEROING

At periodic intervals the microprocessor will automatically execute an AUTO-zero cycle consisting of the following sequence: The transmitter output and display signals are put on *Hold*; a valve is activated which disconnects the process high pressure from the high port of the transducer and connects the process static pressure to both sides of the transducer, creating a true zero differential pressure; after a brief stabilization period, the transducer zero offset signal is measured and stored in memory; the valve is deactivated and after a brief period for process signal stabilization, the *Hold* is released and *Normal* process measurement resumes. **auto zero** will be displayed whenever AUTO-zero cycle is in progress.

During *Normal* operation, the zero offset value stored in memory is subtracted from subsequent transducer readings until the next AUTO-zero cycle occurs and repeats the process. For calibration purposes a switch is provided which allows the user to manually activate the zeroing valve AUTO-zero On/Off and Interval are available and configurable using the User Setup menu.

### 3.4 – DATA DISPLAY

The large integral display is a backlit graphical LCD that displays the current measured process, and is used during configuration.

### 3.5 – HIGH TURNDOWN RATIO OPERATION

The VELTRON DPT 2500-*plus* transmitter, with its high level of accuracy and automatic zeroing circuitry, can maintain linear output signals on applications requiring velocity turndown of 10 to 1 (equal to a velocity pressure turndown of 100 to 1).

### 3.6 – ENCLOSURE

The VELTRON DPT 2500-*plus* transmitter is packaged in a NEMA Type 1 enclosure with standard industrial process connections. A NEMA Type 12 enclosure is optionally available.

### 3.7 – MULTIPLE OPERATING POWER SELECTIONS

The VELTRON DPT 2500-*plus* can be powered by 24VAC or 24VDC.



## 4 – INSTALLATION

### 4.1 – RECEIVING AND INSPECTION

- Carefully remove the VELTRON DPT 2500-*plus* from the shipping container and inspect for any damage. If any damage has occurred in transit, contact freight carrier.
- Save the shipping container for possible future use in returning the VELTRON DPT 2500-*plus* to the factory for recalibration.
- Review the Factory Set-Up Information Sheet provided with the unit and verify the WO # and Serial # match those on the VELTRON DPT 2500-*plus*. Verify that the configuration recorded on the Factory Set-Up Information Sheet is correct for your application. If not, contact Air Monitor's Customer Service Department at 1-800-AIRFLOW for further guidance.

**Note:** The VELTRON DPT 2500-*plus* has been configured and calibrated to customer specified parameters (see "Factory Setup Information Sheet" provided with the unit), and requires no additional calibration/verification prior to installation.

### 4.2 – LOCATION

- The standard version of the VELTRON DPT 2500-*plus* is a NEMA 1 enclosure suitable for most clean indoor locations. If additional protection is required, mount unit in an enclosure with adequate NEMA rating.
- The industrial version of the VELTRON DPT 2500-*plus* is housed in a NEMA 12 enclosure (see NEMA ratings for degree of protection).
- The ambient temperature of the selected mounting location must be between +40° to 120°F. Consideration should be given to units exposed to direct sunlight.
- The selected mounting location should be rigid and free of vibration.

### 4.3 – MOUNTING

#### ***Mounting***

- Tools Required: Electric drill; #25 (0.1495") bit; screwdriver or nutdriver; and four #8-32 self-tapping machine screws.
- The VELTRON DPT 2500-*plus* can be mounted in any position provided it is secured using all four mounting holes.
- Reasonable consideration should be given to clearances for pressure and electrical connections.
- Once a suitable location is found, use the unit as a template to mark the centers of the four mounting holes.
- Drill four pilot holes at the marked locations. With the unit in position, install the four #8-32 screws.

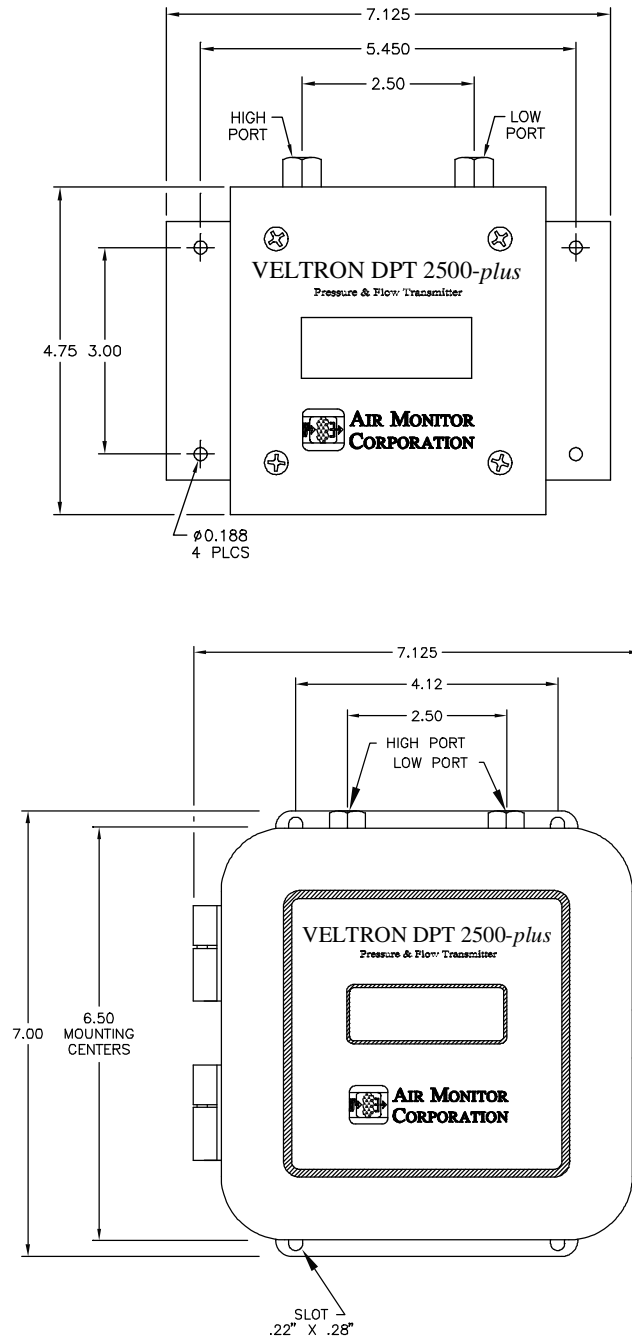

Figure 4.1

### 4.4 – PROCESS CONNECTIONS

The VELTRON DPT 2500-*plus* comes standard with brass 1/8" FPT connection fittings (or special fittings if ordered). To these connect the appropriate fittings for the type and size of signal tubing used. Although any size tubing can be used, the response time of the VELTRON DPT 2500-*plus* to process change can increase if there is an increase in tubing size or an increase in tube length. The following table lists recommended tube size versus length.

Signal Line Length	Recommended Tube Size
Up to 50'	1/4"
50' to 200'	3/8"
Over 200'	1/2"

When connecting the VELTRON DPT 2500-*plus* to an airflow measuring device, connections must be completed as follows:

- High port on the VELTRON DPT 2500-*plus* connects to Total Pressure from the airflow measuring device.
- Low port on the VELTRON DPT 2500-*plus* connects to Static Pressure from the airflow measuring device.

When connecting the VELTRON DPT 2500-*plus* for positive room pressurization, connections must be completed as follows:

- High port on the VELTRON DPT 2500-*plus* connects to sensor from monitored room.
- Low port on the VELTRON DPT 2500-*plus* connects to reference sensor.

When connecting the VELTRON DPT 2500-*plus* for negative room pressurization, connections must be completed as follows:

- High port on the VELTRON DPT 2500-*plus* connects to reference sensor.
- Low port on the VELTRON DPT 2500-*plus* connects to sensor from monitored room.

**CAUTION**

It is extremely important that no pressure be present in signal tubing at the time of installation, and the orientation of High and Low pressure signal lines is maintained between the source and the VELTRON DPT 2500-*plus*.

When making any tubing connections or changing fittings, use a 9/16" wrench to prevent the 1/8" FPT bulkhead fitting from turning.

### 4.5 – POWER/SIGNAL CONNECTIONS

All wiring is done at the terminal strip of the VELTRON DPT 2500-*plus*. The cover needs to be opened or removed to gain access to the terminal strip. On the industrial version, the signal/power wires need to be routed through the conduit connection on the bottom side of the enclosure. It is recommended that wiring be between 14 awg and 22 awg, and no more than two wires should be connected to any one terminal. Follow Figure 4.2 below to connect the Power/Signal wires.

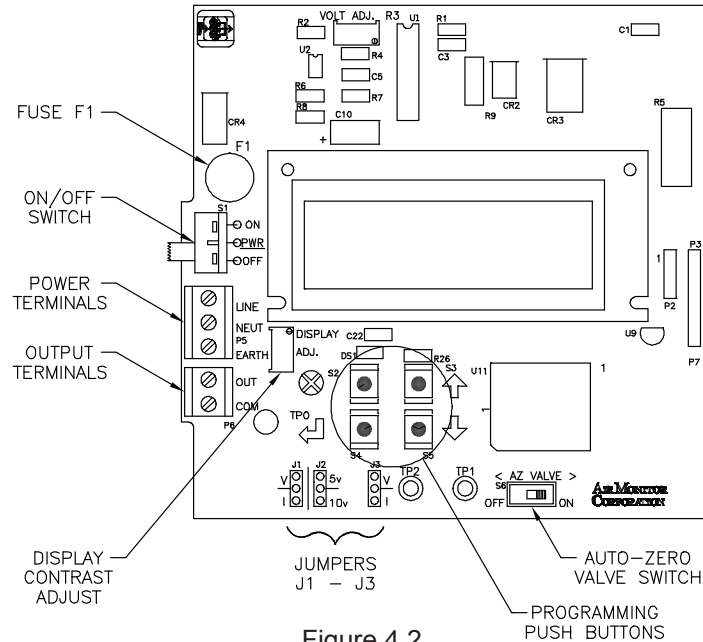

Figure 4.2

**POWER 24V AC/DC.** Power required by the VELTRON DPT 2500-*plus* must be connected to the two terminals labeled LINE(+) and NEUT(-). Earth ground should be connected to the terminal labeled EARTH. Power Supply must be 20-28VAC or 20-32VDC.

**OUTPUT.** This output is sourced (powered) by the VELTRON DPT 2500-*plus*, and can be configured for 0-5VDC, 0-10VDC, or 4-20mADC. Review the Factory Set-Up Information Sheet for your unit's configuration.

- 0-5VDC: Minimum load resistance is 2500 ohms.
- 0-10VDC: Minimum load resistance is 5000 ohms.
- 4-20mADC: Maximum load resistance is 750 ohms.

### 4.6 – OUTPUT SELECTION

Selection of output type (0-5V, 0-10V, or 4-20mA) is made via jumpers J1 through J3 (see Figure 4.2). The selection of voltage or current output is made with J1 and J3 which both must be in the same position V or I. The selection of 5V or 10V is made with J2. (If current is selected with J1 and J3, J2 has no effect, and can be left in either position.)

Note: If output jumpers are changed from factory setting, output calibration should be performed (see Section 6.4) to ensure accurate outputs.

### 4.7 – DISPLAY CONTRAST ADJUSTMENT

To compensate for different ambient lighting conditions and viewing angles, the VELTRON DPT 2500-*plus* display's contrast can be adjusted for optimum visibility. Contrast is adjusted using potentiometer R20 (see Figure 4.2). Turn R20 clockwise to increase contrast (darken characters relative to background) or counterclockwise to decrease contrast.

# 5 – OPERATION

## 5.1 – INTRODUCTION

The VELTRON DPT 2500-*plus* has been configured and calibrated at the Factory to customer specified parameters which are recorded on the VELTRON DPT 2500-*plus* Factory Information Set-Up Sheet, provided with the unit. Review this information and verify that the VELTRON DPT 2500-*plus* set-up is correct for your application. If any problems or discrepancies are detected, contact Air Monitor's Customer Service Department at 1-800-AIRFLOW prior to proceeding.

## 5.2 – START-UP

1. After Installation has been verified in accordance with Section 4 apply power
2. Display will briefly indicate:

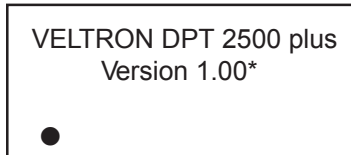

Dot will blink at a rate of once per second.  
\*Your actual version may be different.

Followed by:

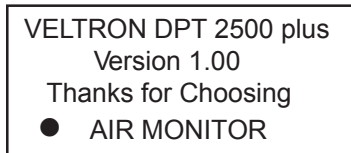

After 5 seconds, display will indicate:



for approximately 5 seconds (to perform AUTO-zero), and then return to *Normal* display mode, and the dot in the lower left of the display indicating CPU Activated will blink rapidly (4 times per second). This is *Normal* operation mode and no further user interface is required. If, however, user would like to verify configuration or change user selectable parameters, continue to Section 5.4 entitled "CONFIGURATION".



### 5.3 – NORMAL OPERATION

Under *Normal* operation the VELTRON DPT 2500-*plus* display will continuously indicate the current monitored process variable, as the example below shows.



**AUTO-zero.** At periodical intervals\* (see Factory Set-Up Information Sheet) the AUTO-zero cycle will be initiated. When this occurs, the display values and outputs will remain constant and **auto zero** will appear in the upper right of the display for the duration of the AUTO-zero cycle.

This cycle will not occur if AUTO-zero has been turned OFF in configuration programming (see Section 5.9).

The AUTO-zero cycle can be manually activated by user (if ON in configuration programming) by simultaneously pressing  and . Cover must be removed to gain access to pushbuttons (see Section 5.4).

If **auto zero** remains on after the AUTO-zero cycle is complete or flashes rapidly, refer to Section 8 - Troubleshooting for required action.

### 5.4 – CONFIGURATION

The VELTRON DPT 2500-*plus* onboard microprocessor controls Configuration: Operating parameter selection; input/output activation and scaling, display scaling, and transducer calibration.

The customer can verify configuration and change certain parameters (within defined ranges) by entering the VELTRON DPT 2500-*plus* Configuration mode. This is accomplished using the four pushbuttons located beneath the VELTRON DPT 2500-*plus* display cover. See Figure 4.2 for location of pushbuttons.

To gain access to the programming pushbuttons, the cover must be removed.

**CAUTION:** With cover removed, ESD (electrostatic discharge) precautions should be observed at all times to protect sensitive components.









### 5.5 – PUSHBUTTON DEFINITION

The four pushbuttons used to interface with the VELTRON DPT 2500-*plus* are identified by their symbols. The symbols are defined as follows:





 : UP     
  : DOWN     
  : ENTER     
  : ESCAPE

In addition to Configuration programming, pushbuttons can be used for certain functions when in the *Normal* operation mode. The following list describes the pushbutton function when in the *Normal* operation mode and in the User Setup (programming).















**When in Normal Operation Mode.**

-  +  Manually activates AUTO-zero (if AUTO-zero is ON).
-  +  Displays VELTRON DPT 2500-*plus* and software version number. While software version is displayed, press  and work order number and serial number will be displayed. Press  and ID (if any) will be displayed. Press  and the display will go back to the *Normal* operation mode.
-  then  Activates the User Setup menu.

**When in User Setup.**

-  or  Use to scroll to the desired Main Menu item.  
Use to scroll to the value or mode within a parameter.
-  Enters user into specific selection sub-menu from Main Menu Selection.  
Displays current setting of selected Parameter. Enters the selected value or setting into memory
-  Use as an escape key to exit Main Menu selection to avoid scrolling to "Return to MAIN MENU".

The following pushbutton combinations can be used to more quickly set user selected values (i.e. Process Min and Max Values, Transducer Operating Span, etc.).

- \* +  Increase the second column digit.
- \* +  Decrease the second column digit.
- \* +  Increase the third column digit.
- \* +  Decrease the third column digit.
- \* +  and  Increase the fourth column digit.
- \* +  and  Decrease the fourth column digit.

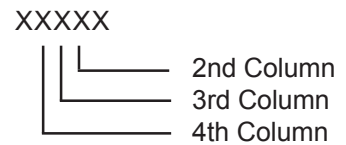

\*Must be pressed and held before other button(s) are pressed.

Note: Pushbuttons are momentary type and should be quickly pressed and released to initiate desired change, unless otherwise instructed to press and hold.



### 5.6 – CONFIGURATION PROGRAMMING

With power ON and initialization complete (see Section 5.2), press and  display will indicate:

USER SETUP

Pressing  will enter the user into the Main Menu of configuration programming. The display will indicate:

Transmitter Scaling  
and Configuration

By using  and  , the user can scroll through the following selections:

MAIN MENU SELECTION	DESCRIPTION
Transmitter Scaling & Configuration	Allows for the configuration of process variable such as: Square root ON/OFF, process type, process minimum/ maximum/units, and percent lockdown.
Low Pass Filter Selection	Selects amount of filtering applied to transducer output and to the display
AUTO-zero Configuration	Turns AUTO-zero function ON or OFF, and selects activation interval.
Transducer Span Selection	Allows for displaying the natural span of the installed transducer, and selecting the operating span.
Transmitter Input Calibration	Allows for the zeroing and spanning transmitter analog Inputs.
Transmitter Output Calibration	Allows for the zeroing and spanning of transmitter analog Outputs.
Exit User Setup	Returns display to <i>Normal</i> operation.



### 5.6 – CONFIGURATION PROGRAMMING (con't)

Once the desired Selection is displayed, its sub-menu can be entered by pressing  .

To better understand the process of Configuration Programming, arrows with pushbutton designations have been included on the following flow chart of AUTO-zero Configuration. This will aid in the navigation of the Configuration Programming Process.

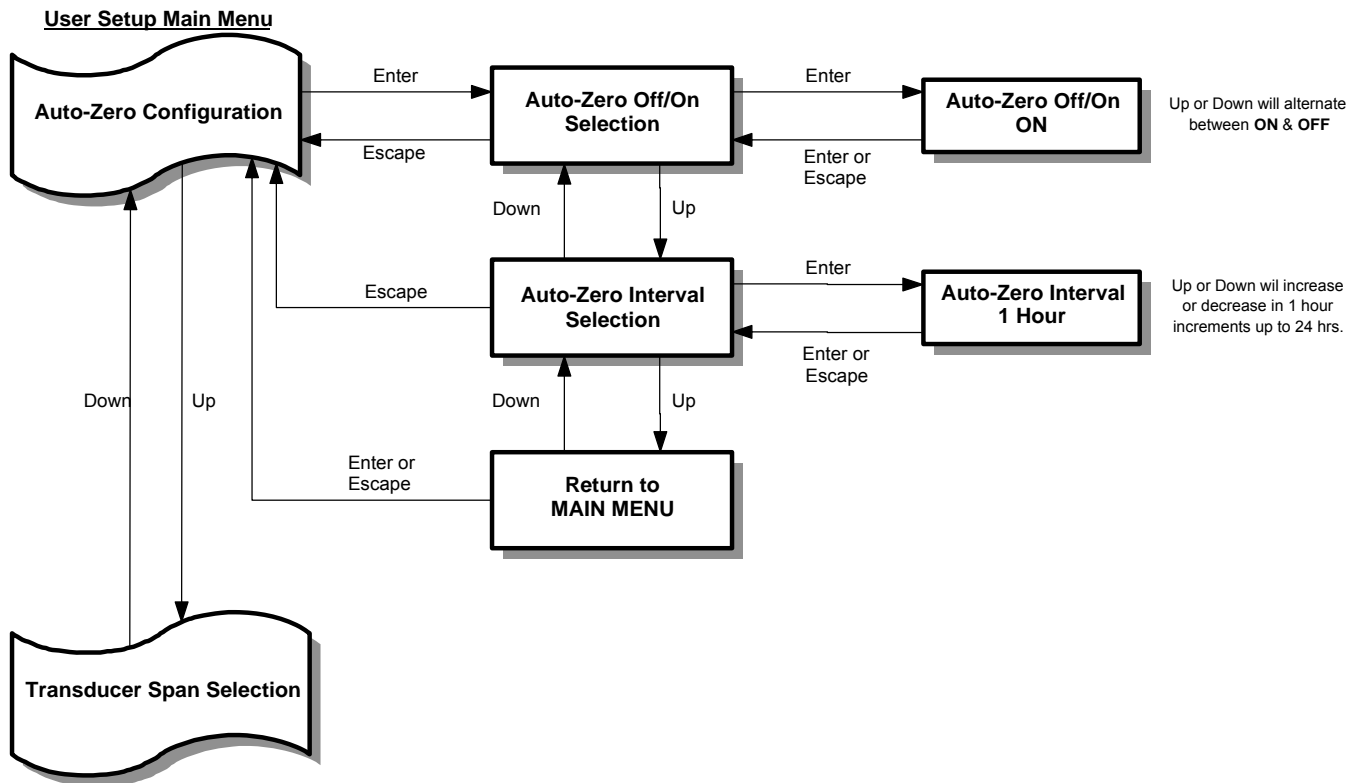

This example of navigation is similar for all Main Menu selections.

The remainder of this Section details steps to verify or change Configuration Programming of all Main Menu Selections.

At any time while in the Main Menu, User can return to *Normal* operation mode by pressing  or scrolling to:





### 5.7 – TRANSMITTER SCALING & CONFIGURATION

This Main Menu selection is where all application specific data is entered to configure the VELTRON DPT 2500-*plus* for a unique application. Typical data includes: Process Type, Process Units, Process Minimum/Maximum, and Output Lockdown.

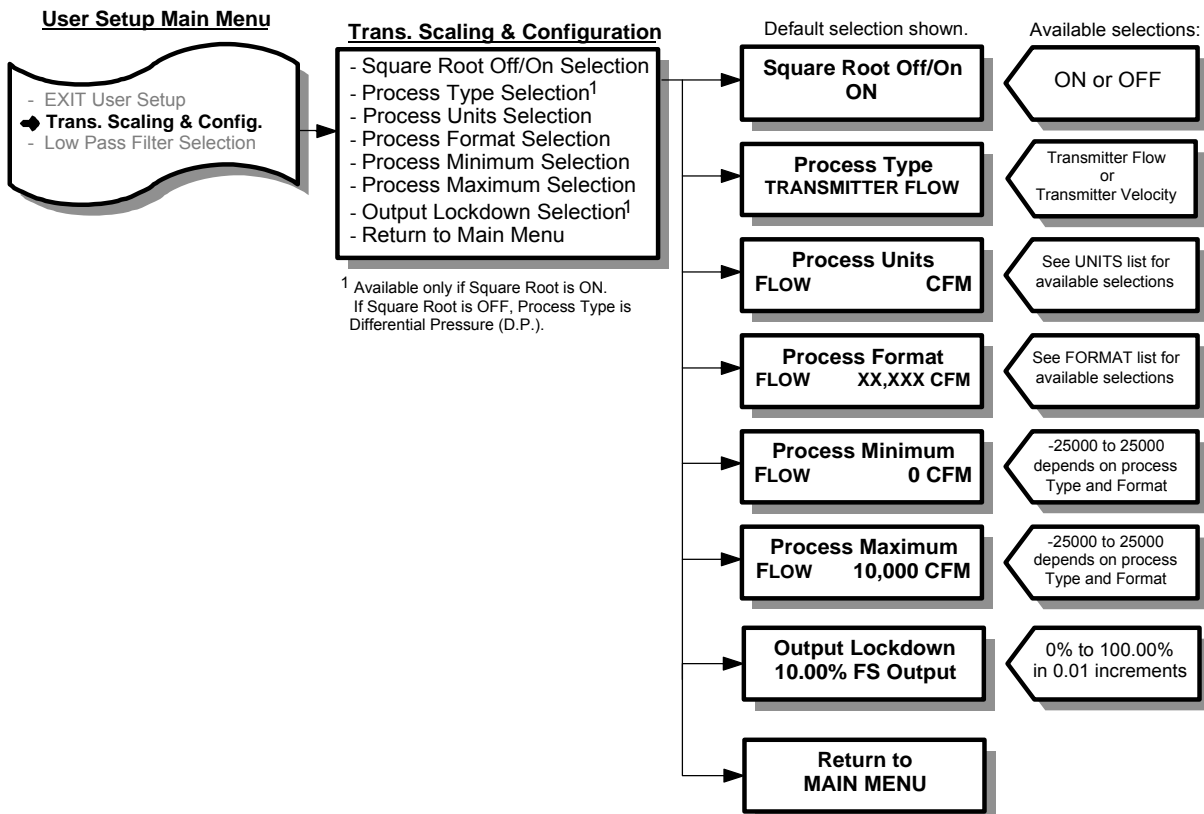
Note: Factory has entered data in this section based on customer supplied information. Data can be reviewed and verified by scrolling through the individual menu items or reviewing the Factory Set-Up Information sheet provided with the unit. Review this information **BEFORE** making any changes, as they can have a significant affect on the operation of the VELTRON DPT 2500-*plus*.



### 5.7 – TRANSMITTER SCALING & CONFIGURATION (con't)



1. While in Main Menu, use  or  to scroll to:

Transmitter Scaling and Configuration
--



2. Press  to enter Transmitter Scaling & Configuration menu. Display will indicate:

Square Root On/Of Configuration
------------------------------------

3. Press  and display will indicate current setting of Square Root (OFF or ON).

4. Use  or  to change setting. Once desired setting is displayed, press , new setting will be stored in memory and display will return to Transmitter Scaling & Configuration menu as in Step 2.

Note: If user desires not to change the setting and return to the Transmitter Scaling & Configuration sub-menu, press . Unit will remain programmed as it was originally

5. Use  or  to select remaining parameters to be changed within the Process Configuration sub-menu.

See the following Units Lists for the available Process Units selections for the appropriate Process Type.  
See the following Format List for the available Process Format selections.

6. Follow Step 4 to make any changes to parameters.

7. To return to the Main Menu, select Return to Main Menu in the Transmitter Scaling & Configuration menu and press .

Note: If Process Minimum is selected to be a value greater than zero (0), Output will not increase until the actual process exceeds this selected value. This is known as "Zero Suppression".

Zero Suppression (Process Minimum) can be set up to 60% of the Process Maximum selected.

Display of process is not affected by this selection, and will indicate the actual process value.

**5.7 – TRANSMITTER SCALING & CONFIGURATION (con't)**

<b>UNITS LIST for Process Type – Flow</b>	
<b>UNIT OF MEASUREMENT</b>	<b>DISPLAY</b>
cubic feet per second	CFS
cubic feet per minute	CFM
cubic feet per hour	CFH
liters per second	l/s
liters per minute	l/m
liters per hour	l/hr
cubic meters per second	m3/s
cubic meters per minute	m3/m
cubic meters per hour	m3/hr
Actual cubic feet per second	ACFS
Actual cubic feet per minute	ACFM
Actual cubic feet per hour	ACFH
Actual liters per second	Al/s
Actual liters per minute	Al/m
Actual liters per hour	Al/hr
Actual cubic meters per second	Am3/s
Actual cubic meters per minute	Am3/m
Actual cubic meters per hour	Am3/h
Standard cubic feet per second	SCFS
Standard cubic feet per minute	SCFM
Standard cubic feet per hour	SCFH
Standard liters per second	Sl/s
Standard liters per minute	Sl/m
Standard liters per hour	Sl/hr
Standard cubic meters per second	Sm3/s
Standard cubic meters per minute	Sm3/m
Standard cubic meters per hour	Sm3/h
Normal liters per second	Nl/s
Normal liters per minute	Nl/m
Normal liters per hour	Nl/hr
Normal cubic meters per second	Nm3/s
Normal cubic meters per minute	Nm3/m
Normal cubic meters per hour	Nm3/h
pounds per second	lb/s
pounds per minute	lb/m
pounds per hour	lb/hr
Tons per hour	T/hr
Tons per day	T/day
grams per second	gm/s
kilograms per hour	kg/hr
Percent	%

**5.7 – TRANSMITTER SCALING & CONFIGURATION (con't)**

<b>UNITS LIST for Process Type – Velocity</b>	
<b>UNIT OF MEASUREMENT</b>	<b>DISPLAY</b>
feet per second	FPS
feet per minute	FPM
feet per hour	FPH
meters per second	m/s
meters per minute	m/m
meters per hour	m/hr
Actual feet per second	AFPS
Actual feet per minute	AFPM
Actual feet per hour	AFPH
Actual meters per second	Am/s
Actual meters per minute	Am/m
Actual meters per hour	Am/hr
Standard feet per second	SFPS
Standard feet per minute	SFPM
Standard feet per hour	SFPH
Standard meters per second	Sm/s
Standard meters per minute	Sm/m
Standard meters per hour	Sm/hr
Normal meters per second	Nm/s
Normal meters per minute	Nm/m
Normal meters per hour	Nm/hr
Percent	%

## 5.7 – TRANSMITTER SCALING & CONFIGURATION (con't)

<b>UNITS LIST for Process Type – Differential Pressure</b>	
<b>UNIT OF MEASUREMENT</b>	<b>DISPLAY</b>
inches of water column	in.WC
inches of mercury	in.Hg
pounds per square inch, gauge	psig
Pascals	Pa
kilo Pascals	kPa
bars	bars
millibars	mbars
millimeter of water column	mm WC
millimeter of mercury	mm Hg
kilograms per square meter	kg/m <sup>2</sup>
Percent	%

<b>FORMAT LIST</b>
X.XXXX
XX.XXX
XXX.XX
X,XXX.X
XX,XXX
XXX,XX0
XXXX,X00

### 5.8 – LOW PASS FILTER

User can select level of Process filtering applied to the transducer output\*. Levels are 0 to 10, with 0 representing no filtering, 1 representing minimal filtering (0.125 sec time constant), and 10 representing maximum filtering (64 sec time constant).

\* This filtering affects the output and display.

Display filter only affects the display and is a multiplier to the Process filter (Note: Process filter must be set to a value other than zero for the display filter to be effective).

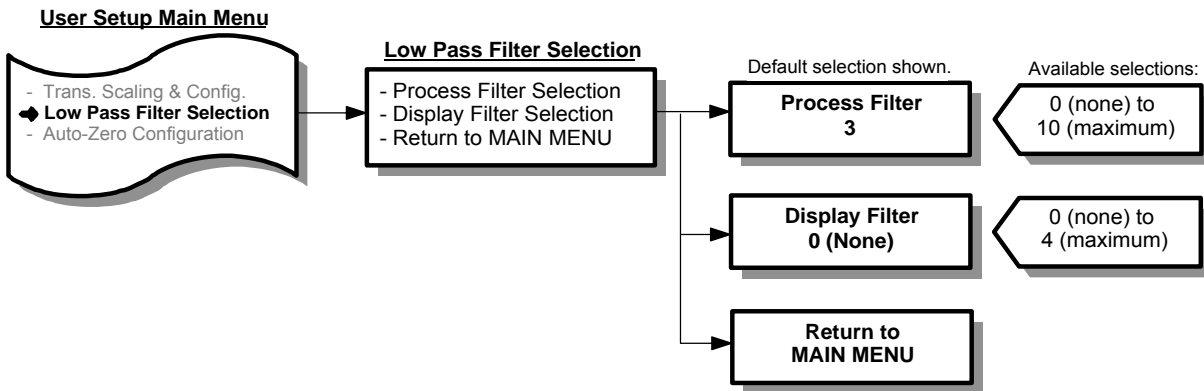

1. While in Main Menu, use or , to scroll to:
 

Low Pass Filter Selection
  2. Press to enter Low Pass Filter Section menu. Display will indicate:
 

Process Filter Selection
  3. Press and display indicates current setting of Process Filter; 0 (none) to 10 (maximum).
  4. Use or to change setting. Once desired setting is displayed, press , new setting will be stored in memory and display will return to Process Filter Selection menu as in Step 2.
- Note: If user desires not to change the setting and return to Main Menu, press . Unit will remain programmed as it was originally.
5. Use or to select remaining parameters to be changed.
  6. Follow Step 4 to make any changes.
  7. To return to Main Menu, select Return to MAIN MENU in Low Pass Filter Selection Menu and press .

### 5.9 – AUTO-zero CONFIGURATION

User can turn AUTO-zero function ON or OFF, and select activation interval.

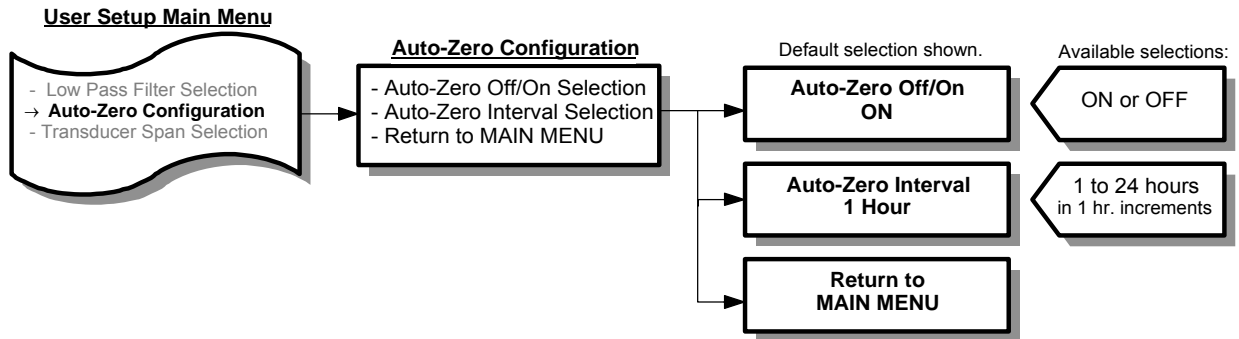

1. While in Main Menu, use or to scroll to:
2. Press to enter AUTO-zero Configuration menu. Display will indicate:
3. Press and display will indicate current setting of AUTO-zero (OFF or ON).
4. Use or to change setting. Once desired setting is displayed, press , new setting will be stored in memory and display will return to AUTO-zero Configuration menu as in Step 2.

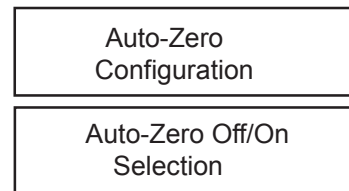

Note: If user desires not to change the setting and return to AUTO-zero Configuration menu press . Unit will remain programmed as it was originally

5. Use or to select remaining parameters to be changed.
6. Follow Step 4 to make any changes to parameters.
7. To return to Main Menu select Return to MAIN MENU in AUTO-zero Configuration menu and press .



### 5.10 – TRANSDUCER SPAN SELECTION

Displays the natural span (maximum full scale span) of the transducer installed in the VELTRON DPT 2500-*plus*. The displayed natural span is for user/technician reference only and should not be changed unless a new transducer of differential natural span has been installed. Also displays the operating span.

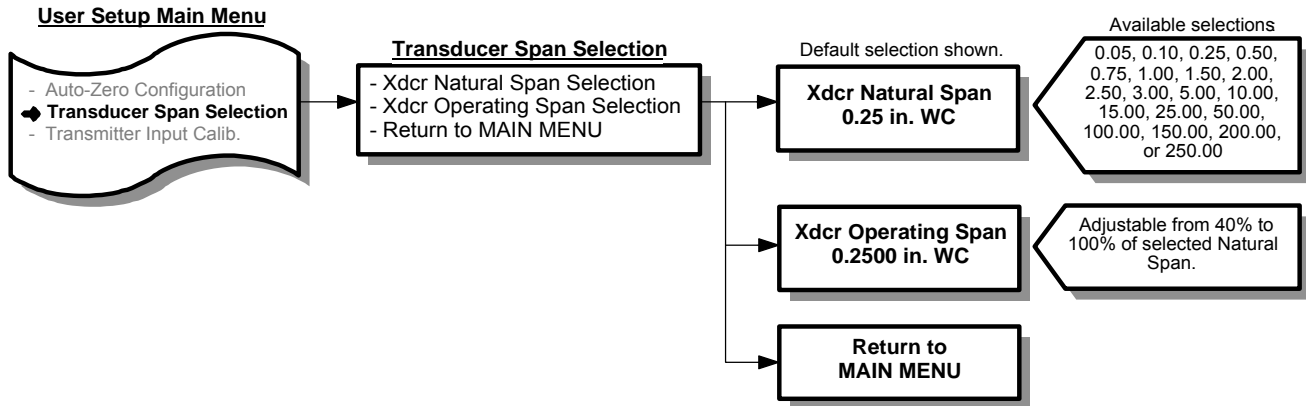

1. While in Main Menu, use or to scroll to: 

Transducer Span Selection
2. Press to enter Transducer Span Selection menu. Display will indicate: 

Xdcr Natural Span Selection
3. Press and display indicates the natural span of the installed transducer (0.05, 0.10, 0.25, 0.50, 0.75, 1.00, 1.50, 2.00, 2.50, 3.00, 5.00, 10.00, 15.00, 25.00, 50.00, 100.00, 150.00, 200.00, or 250 in. WC).
4. Use or to change setting. Once desired setting is displayed press . New setting will be stored in memory and display will return to Main Menu.

Caution: Only change setting if a transducer of different natural span has been installed.

Note: If user desires not to change the setting and return to Main Menu, press . Unit will remain programmed as it was originally.

5. Use or to select remaining parameters to be changed.
6. Follow Step 4 to make any changes to parameters.
7. To return to Main Menu, select Return to MAIN MENU in Transducer Span Selection Menu and press .

Note: If unit is configured as bi-polar, Xdcr Natural Span selections will be in the form of  $\pm x.xx$ , and Xdcr Operating Span will have a Min and Max selection.

### 5.11 – TRANSMITTER INPUT CALIBRATION

See Section 6.3 – Calibration for details on Transmitter Input Calibration.

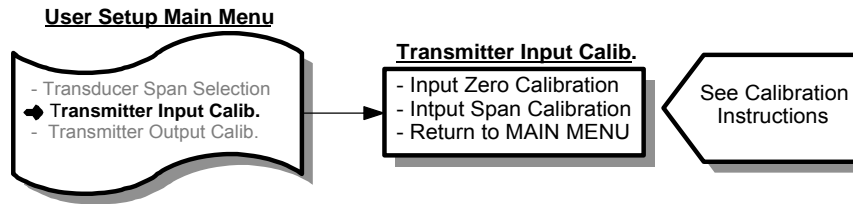

### 5.12 – TRANSMITTER OUTPUT CALIBRATION

See Section 6.4 – Calibration for details on Transmitter Output Calibration.

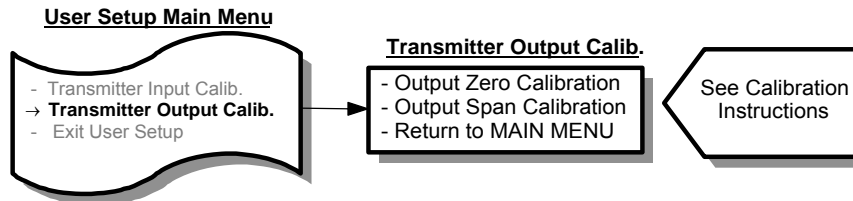

## 6 – CALIBRATION

This section will detail steps necessary to calibrate the VELTRON DPT 2500-*plus*. Calibration is accomplished using the four programming push buttons detailed in Section 5.

This section can be accomplished with the VELTRON DPT 2500-*plus* mounted in its operating location or at a test bench in a calibration lab.

If calibrated at a test bench, the VELTRON DPT 2500-*plus* should be positioned in the same attitude as in its operating location.

### 6.1 – REQUIRED EQUIPMENT

1. Digital Manometer capable of reading to the nearest 0.001" w.c.
2. Digital Multimeter.
3. Source of clean, dry instrument air.
4. Adjustable low pressure regulator, such as AMC "Low Pressure Air Source" or equal.

### 6.2 – PREPARATION

1. Turn Power to the VELTRON DPT 2500-*plus* OFF.
2. Remove or open cover of the VELTRON DPT 2500-*plus*.
3. Slide switch "AZ Valve" to the ON position (see Figure 4.2).
4. Remove Low and High pressure signal lines to the VELTRON DPT 2500-*plus*.
5. Remove all wires connected to output terminals OUT and COM.
6. Turn Power ON.

### 6.3 – TRANSMITTER INPUT CALIBRATION

#### 6.3.1 For Units With Positive or Negative Differential Pressure Spans.

Zero pressure and transducer natural span pressure will be applied to the VELTRON DPT 2500-*plus*, unit will be programmed to recognize these pressures as zero and span for transmitter input calibration.

1. While in Main Menu, scroll to:

Transmitter Input  
Calibration

2. Press , and display will indicate:

Input Zero Calib.

3. Press , and display will indicate:

Input Zero Calib.  
-- Push ENTER --

4. Slide switch S1 - "AZ Valve" to the ON position.

5. Press , and display will indicate:

Transducer Zero  
Settle Time:4

Display will count down to 0, after which it will indicate:

Input Zero Done  
-- Push ESCAPE --

6. Press  and then , display will indicate:

Input Span Calib.

7. Press , and display will indicate:

Input Span Calib.  
-- Push ENTER --

8. Slide switch S1 - "AZ Valve" to the OFF position.

9. Apply input pressure (as read on manometer) to the High port of the VELTRON DPT 2500-*plus*. Adjust pressure to equal the transducer natural span value (see Factory Set-Up Information Sheet for this value).

10. Press , and display will indicate:

Transducer Span  
Settle Time:4

Display will count down to 0, after which it will indicate:

Input Span Done  
-- Push ESCAPE --

Note: If pressure input is less than 40% or greater than 110% of transducer's Natural span value (see Factory Set-Up Information Sheet), display will indicate:

Bad Input Span  
-- Push ESCAPE --

If this occurs, check input pressure (as read on manometer), and readjust as necessary. Press  and repeat Steps 7 through 10.

11. Remove input pressure from High port on VELTRON DPT 2500-*plus*.

12. Press  and then , display will indicate:

Return to  
MAIN MENU

13. Press , and display will return to Main Menu.

### 6.3 – TRANSMITTER INPUT CALIBRATION (con't)

#### 6.3.2 For Units With Bi-Polar Spans.

Minimum and maximum transducer natural span pressure will be applied to the VELTRON DPT 2500-*plus*, unit will be programmed to recognize these pressures as zero and span for transmitter input calibration.

1. Connect input pressure to Low Port of VELTRON DPT 2500-*plus*.

2. While in Main Menu, scroll to:

Transmitter Input  
Calibration

3. Press , and display will indicate:

Input Zero Calib.

4. Press , and display will indicate:

Input Zero Calib.  
-- Push ENTER --

5. Slide switch S1 - "AZ Valve" to the OFF position.

6. Apply input pressure (as read on manometer) to the Low Port of the VELTRON DPT 2500-*plus*. Adjust pressure to equal the positive equivalent of the minimum (negative) transducer natural span value (see Factory Set-Up Information Sheet for this value).

7. Press , and display will indicate:

Transducer Zero  
Settle Time:4

Display will count down to 0, after which it will indicate:

Input Zero Done  
-- Push ESCAPE --

8. Press  and then , display will indicate:

Input Span Calib.

9. Press , and display will indicate:

Input Span Calib.  
-- PUSH ENTER --

10. Connect input pressure to the High Port of the VELTRON DPT 2500-*plus*.

11. Apply input pressure (as read on manometer) to the High Port of the VELTRON DPT 2500-*plus*. Adjust pressure to equal the maximum (positive) transducer natural span value (see Factory Set-Up Information Sheet for this value).

12. Press , and display will indicate:

Transducer Span  
Settle Time:4

Display will count down to 0, after which it will indicate:

Input Span Done  
-- Push ESCAPE --

Note: If pressure input is less than 40% or greater than 110% of transducer's maximum (positive) Natural span value range (see Factory Set-Up Information Sheet), display will indicate:

Bad Input Span  
-- Push ESCAPE --

If this occurs, check input pressure (as read on manometer), and readjust as necessary. Press  and repeat Steps 9 through 12.

## 6.3 – TRANSMITTER INPUT CALIBRATION (con't)

### 6.3.2 (con't)

13. Remove input pressure from High port on VELTRON DPT 2500-*plus*.

14. Press  and then  , display will indicate:

Return to  
MAIN MENU

15. Press  , and display will be in Main Menu.

### 6.4 – TRANSMITTER OUTPUT CALIBRATION

1. Scroll Main Menu to:

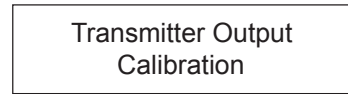

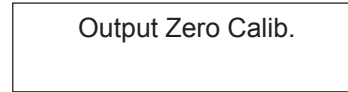

2. Press , and display will indicate:



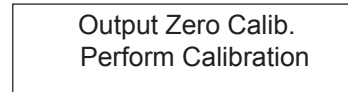

















3. Press , and display will indicate:



4. Connect a DMM set for the type of output your unit is configured for DMM should be reading minimum value of (4.00 ± 0.01mA or 0 ± 0.01VDC).

5. If DMM is reading out of tolerance, use  or  to adjust VELTRON DPT 2500-*plus* output for an acceptable DMM reading.

Depending on DMM's selected range the  or  button may need to be pressed and held for a period of time before any change occurs in the DMM's display. To speed up changes in output, pushbutton combinations can be used. The following chart lists these combinations along with the associated change in output.

<u>PUSHBUTTON COMBINATION</u>	<u>4-20mA</u>
 only	+0.001mA
 only	-0.001mA
 * + 	+0.01mA
 * + 	-0.01mA
 * + 	+0.1mA
 * + 	-0.1mA
 * +  and 	+1.0mA
 * +  and 	-1.0mA

\*Must be pressed and held before other button(s) are pressed.

## 6.4 – TRANSMITTER OUTPUT CALIBRATION (con't)



6. Once an acceptable zero reading is obtained press  and then  and display will indicate:

Output Span Calib.

7. Press , and display will indicate:

Output Span Calib.  
Perform Calibration

8. With DMM still connected as in Step 4, reading should be at maximum value of  $20.00 \pm 0.01\text{mA}$ ,  $5.00 \pm 0.01\text{VDC}$ , or  $10.00 \pm 0.01\text{VDC}$ .

9. If DMM is reading out of tolerance, use  or  to adjust VELTRON DPT 2500-*plus* output for an acceptable DMM reading.

10. Once an acceptable span reading is obtained, press  and then  and display will indicate.

Return to  
MAIN MENU

11. Press  and scroll Main Menu to:

EXIT  
User Setup

12. Press  and VELTRON DPT 2500-*plus* will return to *Normal* mode of operation.



## 7 – MAINTENANCE

The VELTRON DPT 2500-*plus* is a solid state device having few mechanical parts requiring special periodic maintenance. The following maintenance steps are not requirements, but guidelines for establishing a maintenance program for your specific installation.

Operating experience should be used to set frequency of specific types of maintenance.

### 7.1 – CLEANLINESS

- Verify condensation (or other sources of liquids) are not present inside the VELTRON DPT 2500-*plus*.

### 7.2 – MECHANICAL

- Verify pressure signal connections are secure.
- Inspect pressure signal lines for any cracks or leaks.
- Verify mounting hardware is secure.

### 7.3 – ELECTRICAL

- Periodically inspect all wiring to the VELTRON DPT 2500-*plus* for good connections and absence of corrosion.

### 7.4 – CALIBRATION

- VELTRON DPT 2500-*plus* should have calibration verified annually as a minimum.

# 8 – TROUBLESHOOTING

Personnel should be familiar with the operation of the VELTRON DPT 2500-*plus* (see Section 5) before performing any troubleshooting.

Note: Prior to performing any troubleshooting, turn power OFF. After 10 seconds, turn power switch ON. If problem still exists, proceed with troubleshooting steps.

<i><b>Problem</b></i>	<i><b>Solution</b></i>
No Display and "CPU Activated" • is not blinking.	<ul style="list-style-type: none"> <li>– Verify input power is present at the correct voltage as listed on label at the Power Terminals.</li> <li>– Check fuse F1 (1 amp) (see Figure 4.2 for location).</li> </ul>
No output or incorrect output with display responding correctly to process change.	<ul style="list-style-type: none"> <li>– Review Factory Set-Up Information Sheet for type of output (4-20mA, 0-5V or 0-10V).</li> <li>– Check analog output terminal strip wiring for proper installation.</li> <li>– Perform Transmitter Output Calibration (see Section 6).</li> </ul>
Both output and display are incorrect or not responding to process change.	<ul style="list-style-type: none"> <li>– Verify pressure signal lines are connected correctly .</li> <li>– Verify AUTO-zero valve switch is in the OFF position.</li> <li>– Check for leaky or obstructed lines between VEL TRON DPT 2500-<i>plus</i> and process sensor.</li> <li>– Disconnect pressure signal lines and apply light finger pressure to "High" port while monitoring analog output for change. If no change, contact Factory for further information.</li> </ul>
AUTO-zero Function is not working.	<ul style="list-style-type: none"> <li>– Verify AUTO-zero is ON and interval is properly set (see Section 5.9).</li> <li>– Verify AUTO-zero valve switch is in the OFF position.</li> </ul>
<b>auto zero</b> is continuously lit.	<ul style="list-style-type: none"> <li>– Zero value measured during AUTO-zero cycle is between 90% and 100% of operating span. Transmitter Input Calibration should be performed as soon as possible (see Section 6.3).</li> </ul>
<b>auto zero</b> is flashing rapidly.	<ul style="list-style-type: none"> <li>– Zero value measured during AUTO-zero cycle is greater than 100% of operating span. Transmitter Input Calibration should be performed immediately (see Section 6.3).</li> </ul>
Process Signal is Unreliable is displayed on Line 1 of display.	<ul style="list-style-type: none"> <li>– Verify pressure signal lines are connected correctly (see Section 4.4).</li> <li>– Verify process is operating within design parameters specified on Factory Set-Up Sheet.</li> <li>– Verify pressure signal line bulkhead fittings on the transmitter housing have not been spun causing internal signal tubing to twist.</li> </ul>

If after following the Troubleshooting steps the VELTRON DPT 2500-*plus* continues to operate improperly, contact the Service Department for further assistance (see Section 10).

## 9 – PARTS LIST

- The following drawing with part numbers list components of the VELTRON DPT 2500-*plus* that are easily replaced by the user.
- To inquire about price and availability of a specific part number, please contact the Customer Service Department at:

Phone: 1-707-544-2706      Fax: 1-707-526-2825  
 1-800-AIRFLOW

- When contacting the Customer Service Department about parts, please have the applicable Factory Set-Up Information sheet available for reference.

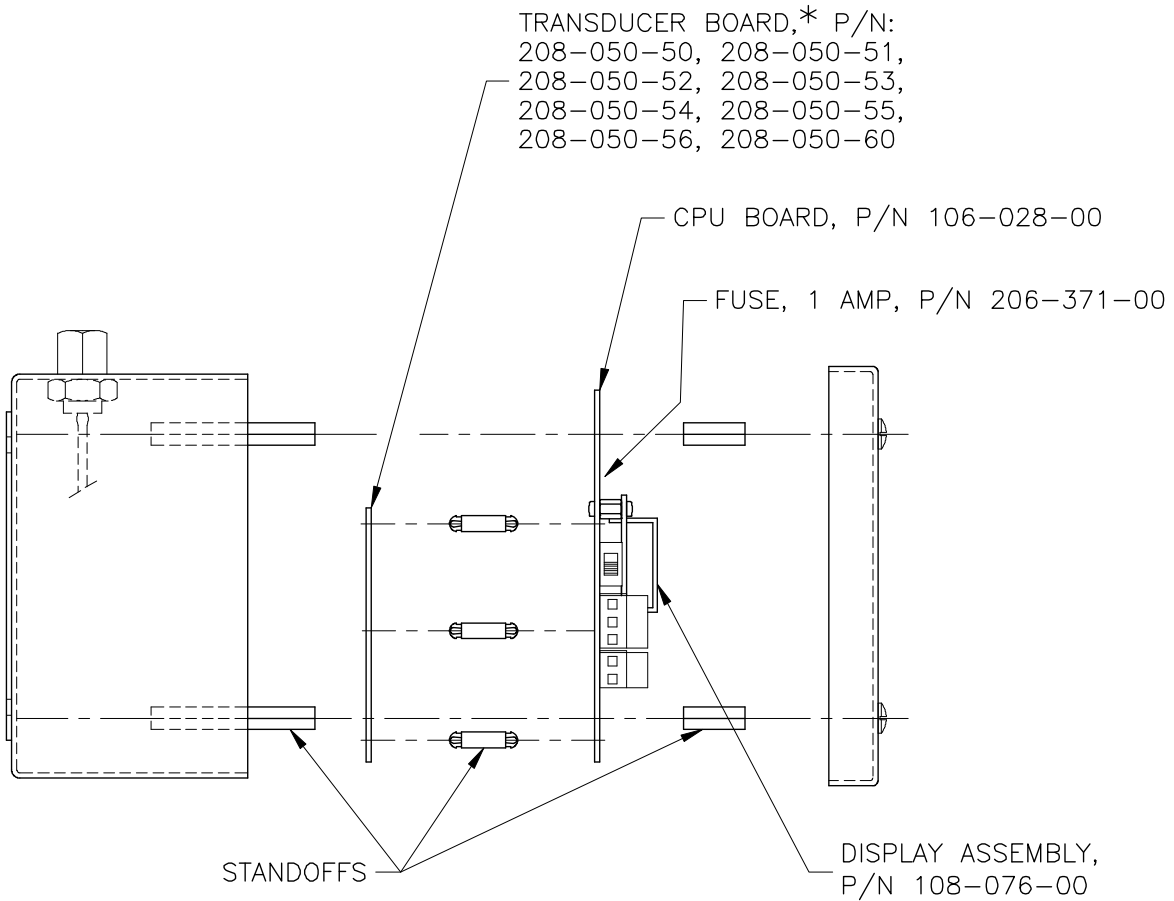

\* NOTE: REFER TO FACTORY SETUP INFORMATION SHEET TO DETERMINE WHICH TRANSDUCER IS UTILIZED IN YOUR UNIT.

## 10 – CUSTOMER SERVICE

### 10.1 – CUSTOMER SERVICE/TECHNICAL SUPPORT

Air Monitor Corporation provides in-house technical support for our products:

Monday through Friday  
7 am to 5 pm (pst)  
Phone: 707-544-2706 or 1-800-AIRFLOW  
Fax: 707-526-2825

Additionally, on-site technical assistance is available. Before contacting the Customer Service Department, please ensure any applicable troubleshooting steps outlined in Section 8 have been performed.

### 10.2 – REPAIRS/RETURNS

If after contacting the Customer Service Department it is determined that equipment will require return to Air Monitor Corporation for further repair, a Return Authorization number will be issued by the Customer Service Department. A Confirmation of Return Authorization with shipping instructions will be sent via facsimile.

Equipment to be returned to Air Monitor should be returned in its original shipping container if possible. If this is not possible, ensure equipment is packaged sufficiently to protect it during shipment.

**CAUTION**  
**All damage occurring during transit is the Customer's responsibility.**

List the Return Authorization (R/A) number on the packing list and clearly mark this number on the outside of each shipping container.

Costs associated with return of equipment to Air Monitor are the customer's responsibility regardless whether the repair/return is under warranty.

### 10.3 – WARRANTY REPAIRS/RETURNS

Once the Customer Service Department determines that the equipment repair is under warranty, the item will be repaired and returned to the customer at no charge.

### 10.4 – NON-WARRANTY REPAIRS/RETURNS

Customer will be invoiced for all parts and labor required for the repair of equipment. Return shipping charges will also be added to invoice.

### 10.5 – FIELD SERVICE

Requests for field service should be made to the Customer Service Department, who will coordinate sending a technician to customer's site.

Phone: 707-544-2706 or 1-800-AIRFLOW  
Fax: 707-526-2825

Upon completion of work, technician completes a Field Service Report and gives a copy to the customer. Field service is charged on a daily basis and all travel expenses are also added to customer's invoice.