

# VELTRON DPT-plus

## MICROPROCESSOR BASED ULTRA-LOW RANGE PRESSURE, FLOW, AND MASS FLOW INDICATING TRANSMITTER

**MOUNTING CONFIGURATIONS**

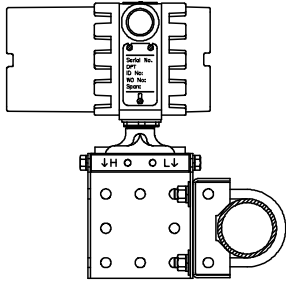

ANGLE MOUNT TO HORIZONTAL PIPE

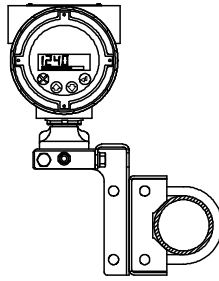

VERTICAL MOUNT TO HORIZONTAL PIPE

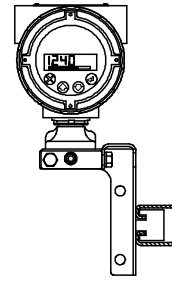

VERTICAL MOUNT TO HORIZONTAL CHANNEL

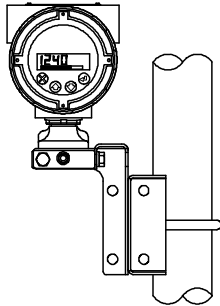

VERTICAL MOUNT TO VERTICAL PIPE

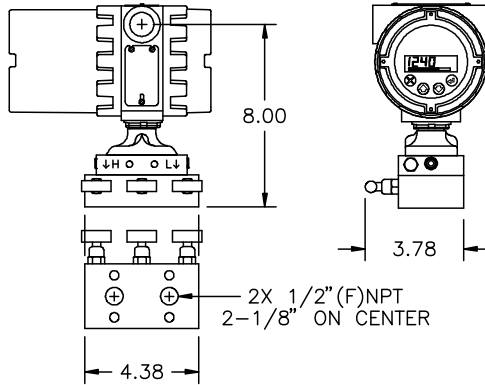

OPTIONAL 3 VALVE MANIFOLD

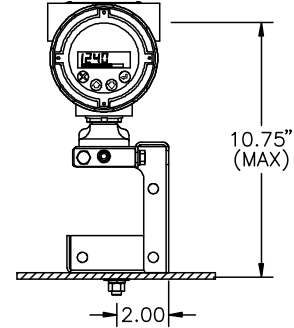

ANGLE MOUNT TO FLAT SURFACE

NOTE: MOUNTING BRACKET KIT INCLUDES 3/8-16 U-BOLTS, NUTS & WASHERS FOR 2" SCH 40 PIPE PLUS 4 BOLTS & WASHERS TO ATTACH THE TRANSMITTER TO THE MOUNTING BRACKET.

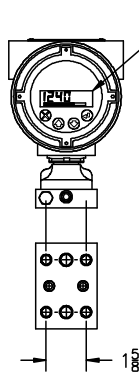

OPTIONAL LCD DISPLAY

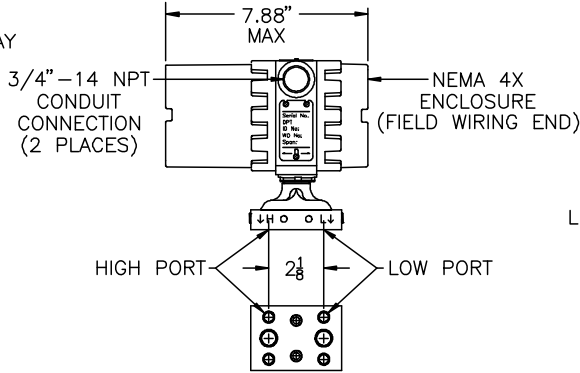

3/4"-14 NPT CONDUIT CONNECTION (2 PLACES)  
NEMA 4X ENCLOSURE (FIELD WIRING END)  
HIGH PORT 2 1/8" LOW PORT

1/4"-18 NPT (FOR PRESSURE CONNECTIONS)

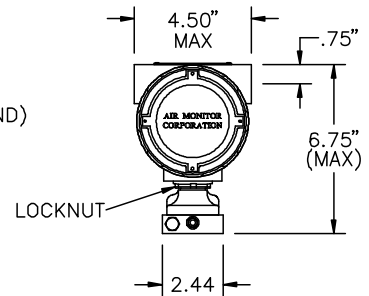

LOCKNUT

